

## ORDER REFERENCE

PROJECT: UC601 CABLE DRUM 1000 LB.  
TYPICAL LAYOUT

PLEASE REFER TO PAGE 7  
OF THE PLANNING GUIDE FOR  
ADDITIONAL SIZING OPTIONS

1000 LB. WINDING DRUM  
OFFERS A MAXIMUM OF:  
6 STOPS  
50'-0" OF TRAVEL  
15 SQ. FT. CAB SIZE

## SPECIFICATIONS

DRIVE: UC601 CABLE DRUM

CAPACITY: 1000#

LANDINGS: 3

MANUFACTURED TO MEET:  
ASME A17.1 – 2016  
IT IS THE RESPONSIBILITY OF THE INSTALLER OF THE UNIT  
TO SATISFY ASME, NEC, STATE, AND LOCAL BUILDING CODES

CODE(S): 6 (INCLINATOR LAYOUT DESIGN)

SPEED: AT 38 F.P.M. ±2

SUSPENSION (2) STEEL WIRE ROPES 12,100#  
MEANS: BREAKING STRENGTH  $\phi 3/8$  – 8 x 19 IWRC

CAR CONSTRUCTION: 3/4" HARDWOOD VENEER

NOTE: ALL MANUFACTURER SUPPLIED CAR AND EQUIPMENT OPTIONS ARE  
NOTED ON THE CONFIRMING ORDER SHEET.

DISCLAIMER: ONCE DRAWINGS HAVE BEEN APPROVED,  
SIGNED AND WITHIN 5 DAYS OF PRODUCTION, THE  
CUSTOMER WILL BEAR ALL RESPONSIBILITY AND LIABILITY  
OF FINISHED UNIT.

DWG VIEW		COVER SHEET		PART NUMBER		REV. DATE	
				80205323		11/21/19	
		DRAWING TITLE		DRAWING NO.		-	
		TYPICAL UC601 WD 1000LB		TYP-WD1000-035		-	
PAGE:	DRAWN BY:	DWG. DATE	JOB OR APP.#	DEALER P.O.#	DWG. SCALE	REV. LEVEL(1-3)	
1/5	S THOMAS	3/2017	-	-	1:24	A	

NOT TO BE USED FOR CONSTRUCTION  
TYPICAL DRAWING

A  
A

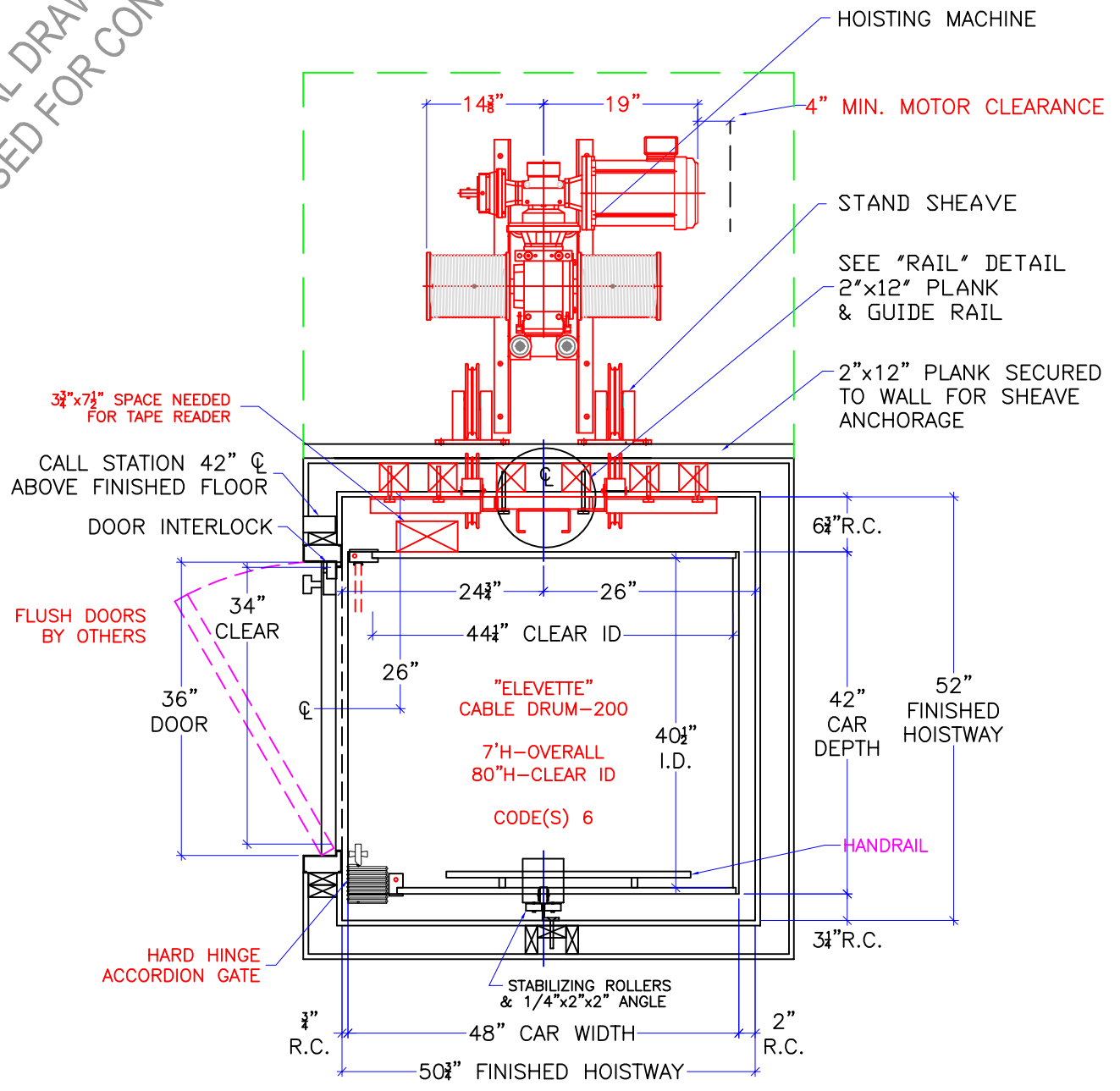

NOTE:  
ALL HOISTWAY CONSTRUCTION MUST COMPLY WITH NATIONAL, STATE,  
AND LOCAL CODES. HOISTWAY MUST BE PLUMB AND STRAIGHT FROM  
TOP TO BOTTOM WITH NO PROJECTIONS INTO THE HOISTWAY.

DWG VIEW		COVER SHEET		PART NUMBER		REV. DATE	
INCLINATOR COMPANY OF AMERICA HARRISBURG, PA		DRAWING TITLE		80205323		11/21/19	
TYPICAL UC601 WD 1000LB		DRAWING NO.		TYP-WD1000-035		-	
PAGE:	DRAWN BY:	DWG. DATE	JOB OR APP.#	DEALER P.O.#	DWG. SCALE	REV. LEVEL(1-3)	
2/5	S THOMAS	3/2017	-	-	1:24	A	

TYPICAL DRAWING  
NOT TO BE USED FOR CONSTRUCTION

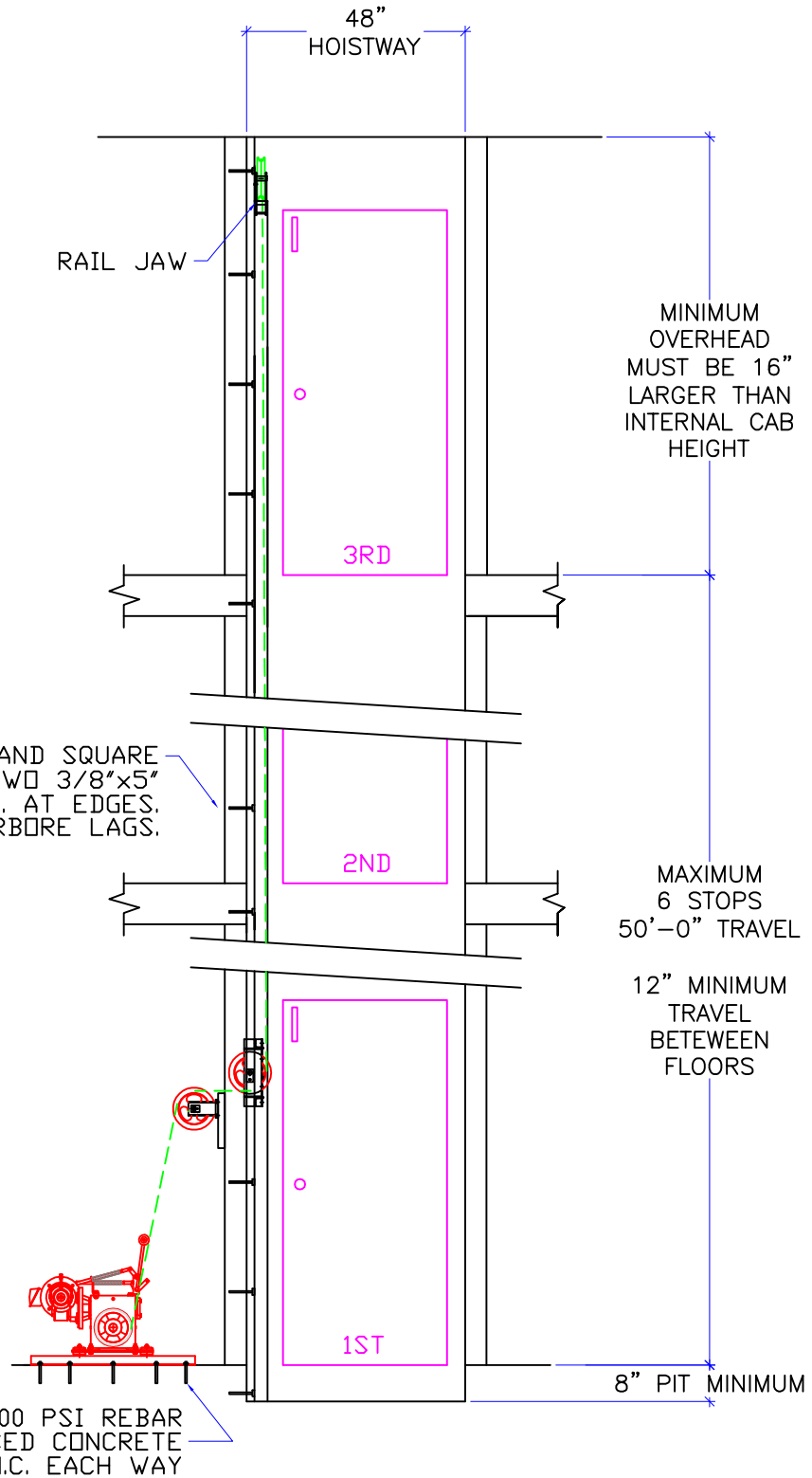

DWG VIEW		COVER SHEET		PART NUMBER		REV. DATE	
				80205323		11/21/19	
INCLINATOR COMPANY OF AMERICA HARRISBURG, PA		DRAWING TITLE		DRAWING NO.		-	
		TYPICAL UC601 WD 1000LB		TYP-WD1000-035		-	
PAGE:	DRAWN BY:	DWG. DATE	JOB OR APP.#	DEALER P.O.#	DWG. SCALE	REV. LEVEL(1-3)	
3/5	S THOMAS	3/2017	-	-	1:24	A	

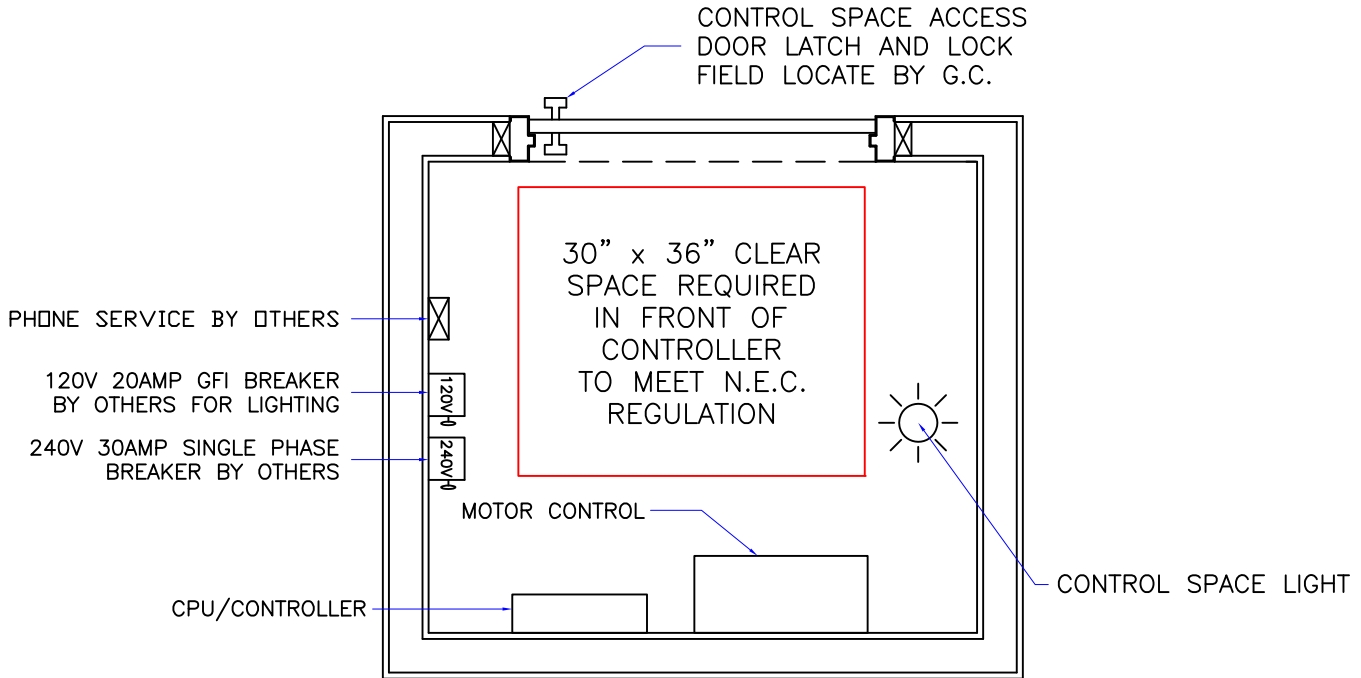

**CPU ENCLOSURE**  
(14"W x 22 3/4"H x 4"D)

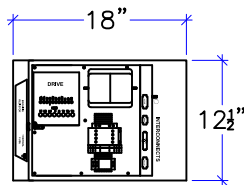

**MOTOR CONTROL ENCLOSURE**  
(18"W x 12 1/2"H x 8"D)

**CONTROLLER SPACE:**

- 1: THE CPU AND MOTOR CONTROL ENCLOSURE SHOULD BE LOCATED IN THE SAME LOCATION. THE RECOMMENDED WIRING DISTANCE FROM THE CPU AND MOTOR CONTROL ENCLOSURE TO THE MOTOR TO BE 10'. LONGER MOTOR CABLES UP TO 50' ARE AVAILABLE. CONSULT WITH INCLINATOR WHEN ORDERING.
- 2: CONTROLLER SHOULD BE MOUNTED IN A TEMPERATURE CONTROLLED ENVIRONMENT BETWEEN 40°F TO 120°F (4°C - 49°C).
- 3: CPU AND MOTOR CONTROL ENCLOSURE SHOULD NOT BE EXPOSED TO OUTDOOR ELEMENTS.
- 4: N.E.C. REGULATIONS REQUIRE A MINIMUM OF 30" WIDE x 36" DEEP x 6'-6" HIGH CLEAR UNOBSTRUCTED SPACE IN FRONT OF CONTROLLER.
5. MACHINE ROOM TO HAVE NATURAL/MECHANICAL VENTILATION IF REQUIRED BY STATE OR LOCAL CODES.
6. MACHINE ROOM LAYOUT MUST COMPLY WITH LOCAL, STATE, AND NATIONAL CODES.

**NOTICE TO ELECTRICAL CONTRACTOR:**

- ALL ELECTRICAL WIRING MUST BE DONE BY A JOURNEYMAN MECHANIC AND MUST MEET ALL NATIONAL, STATE, AND LOCAL CODES.
- BRING (2) #10 W/GND FROM RESIDENCE INCOMING POWER PANEL 30AMP BREAKER (240V, & GROUND) TO THE CONTROLLER SPACE.
- BRING (2) #12 W/GND FROM RESIDENCE INCOMING POWER PANEL 20AMP GFI BREAKER (120V, NEUTRAL, GROUND) TO THE MACHINE ROOM.
- REQUIRED LOW VOLTAGE WIRING IS SUPPLIED BY MANUFACTURER. ALL EXTENSIONS ADDITIONS, ETC. SHALL BE DONE WITH THE SAME SIZE AND TYPE OF WIRE AS ORIGINALLY SUPPLIED BY THE MANUFACTURER.
- A TELEPHONE LINE SHALL BE SUPPLIED TO THE CONTROLLER SPACE AND SHALL BE CONNECTED TO A 24 HOUR CENTRAL EXCHANGE.
- ALL MEANS FOR ACCESS TO EQUIPMENT SHALL BE PROVIDED WITH A LOCK. ALL SHAFT DOORS MUST BE INTERLOCKED.

DWG VIEW		PART NUMBER		REV. DATE		
CONTROLLER SPACE REQUIREMENTS		80205323		-		
DRAWING TITLE		DRAWING NO.		-		
TYPICAL UC601 WD 1000LB		TYP-WD		-		
PAGE:	DRAWN BY:	DWG. DATE	JOB OR APP.#	DEALER P.O.#	DWG. SCALE	REV. LEVEL(1-3)
4/5	S THOMAS	3/2017	-	-	1:24	-



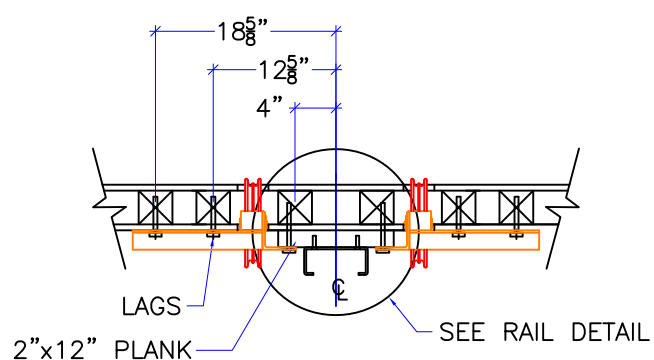
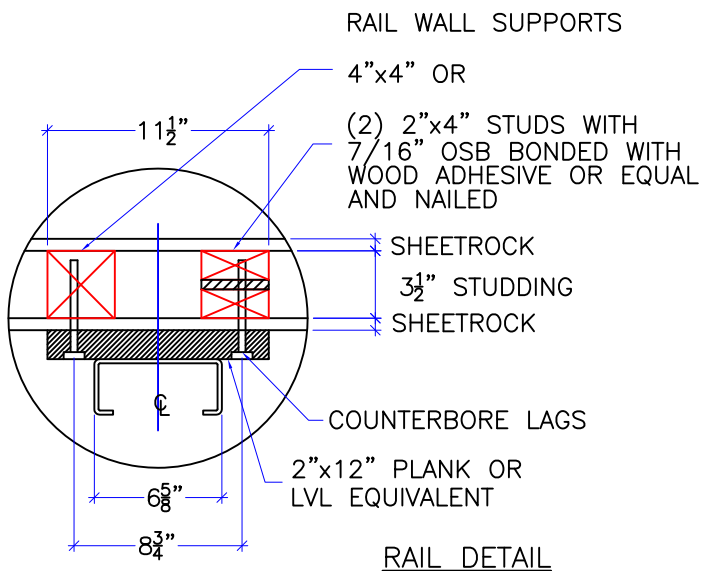

STUD LOCATION FOR THRU THE WALL SHEAVES (IF APPLICABLE)

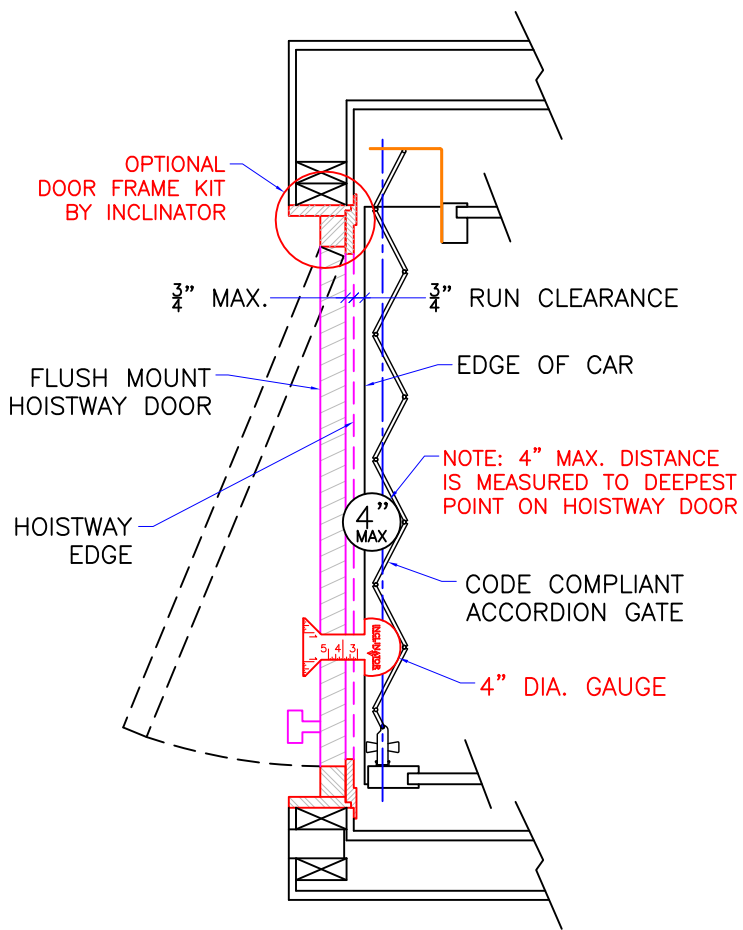

DOOR FRAME DETAILS

REF: ASME 17.1-2016 5.3.1.4.2, 5.3.1.7.2, & 5.3.1.8.3

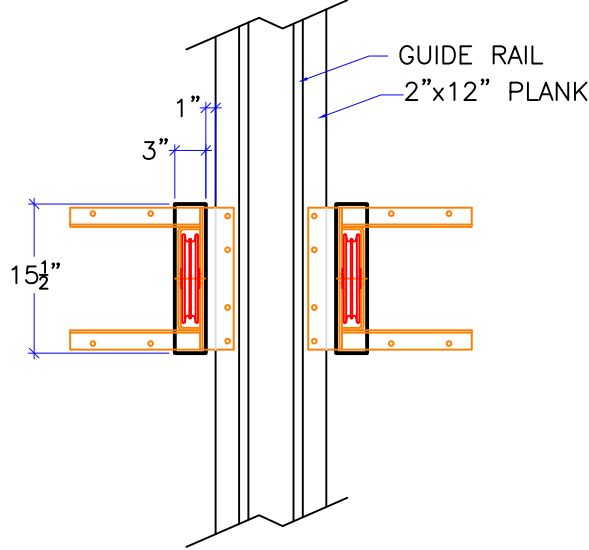

CUTOUT DETAIL (IF APPLICABLE)

1. REACTIONS ON ALL SHEAVES AND MOUNTINGS:  
STATIC = 1,800 LBS.  
IMPACT = 3,600 LBS.
2. FASTENING OF HOISTING MACHINE TO CONCRETE FLOOR:  
MIN. (8) 1/2" ANCHORS, MIN. ULTIMATE STRENGTH OF 5000# EA.
3. RAIL FASTENING TO 2"x12" PLANK:  
#14 x 1 3/4" TYPE A S.M.S. RAIL IS PRE-DRILLED AT FACTORY.
4. BOLT FASTENING OF CAR TO TROLLEY -  
1/2" - 13 x 4" SOCKET HD CAP SCREWS.
5. ALL SHEAVE PITCH DIA. 8 1/8".

TECHNICAL DATA

DWG VIEW		PART NUMBER		REV. DATE		
DETAILS, DATA, CODES		80205323		-		
DRAWING TITLE		DRAWING NO.		-		
TYPICAL UC601 WD 1000LB		TYP-WD		-		
PAGE:	DRAWN BY:	DWG. DATE	JOB OR APP.#	DEALER P.O.#	DWG. SCALE	REV. LEVEL(1-3)
5/5	S THOMAS	3/2017	-	-	1:24	-



SECTION		X - X AXIS						Y - Y AXIS			
MEMBER	WT.	HT.	W	A	I	S	r	Z	I	S	r
		lbs./ft.	in.	in.	in. <sup>2</sup>	in. <sup>4</sup>	in. <sup>3</sup>	in.	in. <sup>4</sup>	in. <sup>3</sup>	in.
SINGLE CHANNEL											
A-1400	1.40	1.625	1.625	.401	.134	.146	.577	.707	.184	.226	.677

LOAD RATINGS FOR 3/8-16 STRUT NUTS USED IN SUPERSTRUT CHANNELS		
CHANNEL NO.	SLIP RESISTANCE LBS.	PULL OUT STRENGTH LBS.
A - 1400	1000	2000



NOMINAL THICKNESS (INCHES)  
 14 GA = .075  
 I - MOMENT OF INERTIA  
 S - SECTION MODULUS  
 r - RADIUS OF GYRATION  
 Z - NEUTRAL AXIS  
 A - AREA

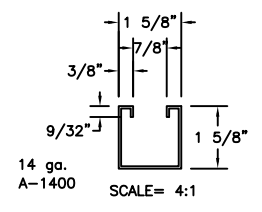

SECTION C-C  
SCALE= 4:1

SUPERSTRUT DETAIL

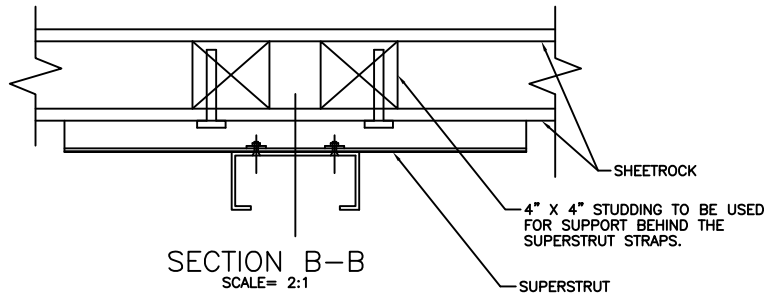

SECTION B-B  
SCALE= 2:1



SECTION A-A  
SCALE= 2:1

## MOUNTING TO CONCRETE

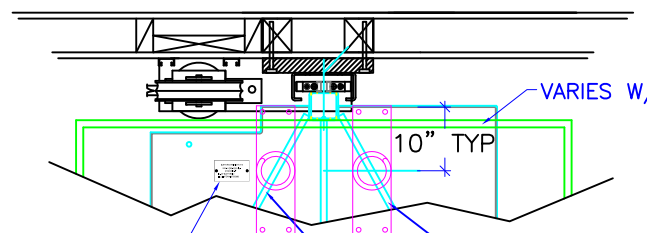

VARIES W/BASE SIZE  
 10" TYP  
 DATA MARKING PLATE  
 CAR BASE STEEL BRACES  
 CAR BASE  
 CAR BUFFERS  
 14" MINIMUM PIT FOR BUFFERS

**SPRING BUFFERS**  
 SPRING WILL DEPRESS 1" AT 373 LBS.  
 (MANUFACTURERS SPECIFICATION)

## BUFFER OPTION

MANDATORY WHEN OCCUPIABLE SPACE BELOW ELEVATOR

DWG VIEW				PART NUMBER		REV. DATE	
OPTIONS				80205323		-	
DRAWING TITLE				DRAWING NO.		-	
TYPICAL UC601 WD 1000LB				TYP-WD		-	
PAGE:	DRAWN BY:	DWG. DATE	JOB OR APP.#	DEALER P.O.#	DWG. SCALE	REV. LEVEL(1-3)	
AUX 1	S THOMAS	3/2017	-	-	1:24	-	



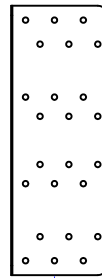

NAIL PLATE  
MOUNTING  
BRACKET  
PROVIDED BY  
INCLINATOR



HALL CALL MOUNTING  
BOX PROVIDED BY  
INCLINATOR

## FLUSH MOUNT HALL CALL STATION

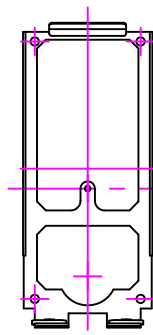
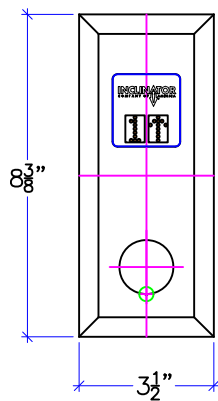

WALL BRACKET  
PROVIDED BY  
INCLINATOR

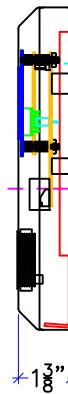

SINGLE GANG  
MOUNT ELECTRICAL  
BOX BY OTHERS

THIS HOLE USED  
TO LOCATE BRACKET  
OVER GANG BOX

## RAISED MOUNT HALL CALL STATION

DWG VIEW				PART NUMBER		REV. DATE	
CALL STATIONS				80205323		-	
DRAWING TITLE				DRAWING NO.		-	
TYPICAL UC601 WD 1000LB				TYP-WD		-	
PAGE:	DRAWN BY:	DWG. DATE	JOB OR APP.#	DEALER P.O.#	DWG. SCALE	REV. LEVEL(1-3)	
AUX 2	S THOMAS	3/2017	-	-	1:24	-	





**DOOR FRAME DETAIL**  
 STANDARD 2x4 CONSTRUCTION WITH  
 1/2" DRYWALL (INSIDE & OUTSIDE OF HOISTWAY)



HALLWAY VIEW



HOISTWAY VIEW

DWG VIEW		PART NUMBER		REV. DATE		
DOOR FRAME KITS		80205323		-		
DRAWING TITLE		DRAWING NO.		-		
TYPICAL UC601 WD 1000LB		21211403		-		
PAGE:	DRAWN BY:	DWG. DATE	JOB OR APP.#	DEALER P.O.#	DWG. SCALE	REV. LEVEL(1-3)
AUX 3	S THOMAS	3/2017	-	-	1:24	-

